

# North American Solutions Center Material Handling Solutions

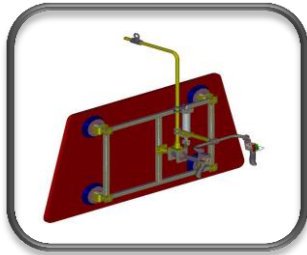

ENGINEERED FOR  
THE INTERACTION OF MAN & MACHINE





VACUUM

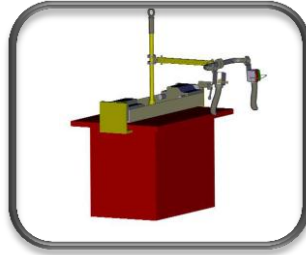

TRAP

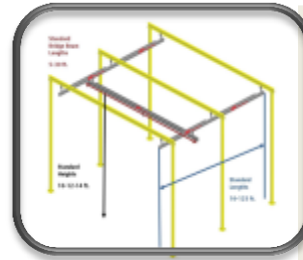

FLOOR SUPPORT



APP DATA

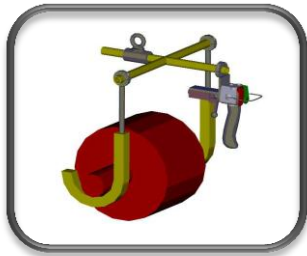

HOOK

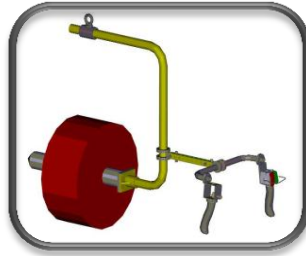

PROBE



PHOTOS



WEB-CATALOG

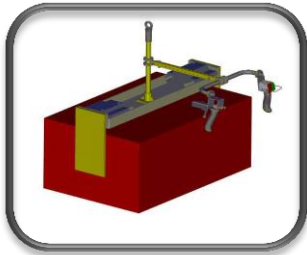

CLAMP

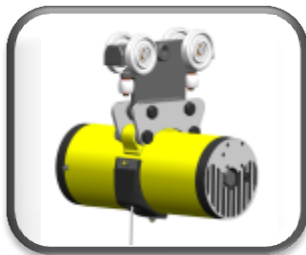

BALANCER



SUPPORT



WEB-VIDEO



HANDLES

Description  
Vacuum Panel Handling Device

REF# 81073887\_1A01



INDEX

Ingersoll Rand  
2955 Stephenson Highway  
Madison Heights, MI 48071  
1-248-398-6200

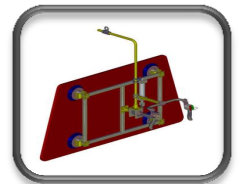

VACUUM



HANDLES

Description  
Vacuum Panel Handling Device

REF# 32437825\_1A02



4-Cup Vacuum

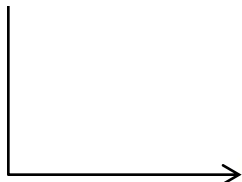

Power Rotate



Power Tilt



Ingersoll Rand  
2955 Stephenson Highway  
Madison Heights, MI 48071  
1-248-398-6200



INDEX

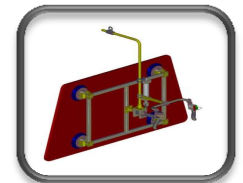

VACUUM



HANDLES



2-Cup Vacuum



Description  
Vacuum Panel Handling Device

REF# 32724993\_1A01



INDEX

Ingersoll Rand  
2955 Stephenson Highway  
Madison Heights, MI 48071  
1-248-398-6200

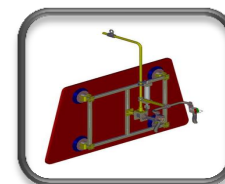

VACUUM



HANDLES

Description  
Vacuum Panel Handling Device

REF# 80480651\_1A01



Ingersoll Rand

Power Rotate

2-Cup Vacuum



INDEX

Ingersoll Rand  
2955 Stephenson Highway  
Madison Heights, MI 48071  
1-248-398-6200

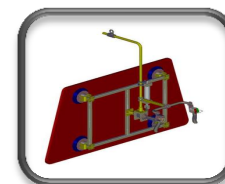

VACUUM



HANDLES

Description  
Vacuum Panel Handling Device

REF# 80744389\_1A01



High Efficiency Vacuum Generators

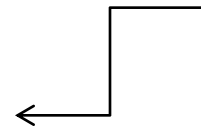

INDEX

Ingersoll Rand  
2955 Stephenson Highway  
Madison Heights, MI 48071  
1-248-398-6200

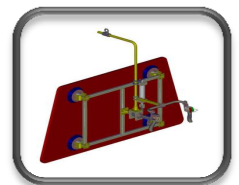

VACUUM





HANDLES



Description  
Vacuum Panel Handling Device

REF# 32704739\_1A01

High Efficiency Vacuum Generators

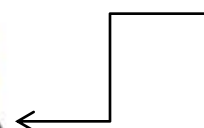

Ingersoll Rand  
2955 Stephenson Highway  
Madison Heights, MI 48071  
1-248-398-6200



INDEX

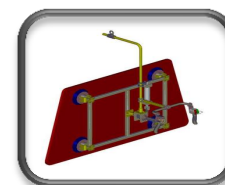

VACUUM





HANDLES



Description  
Vacuum Panel Handling Device

REF# 32354458\_6A01

Power Tilt Cylinder



INDEX

Ingersoll Rand  
2955 Stephenson Highway  
Madison Heights, MI 48071  
1-248-398-6200

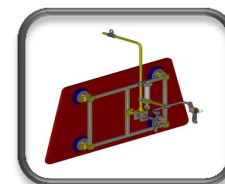

VACUUM



HANDLES



Description  
Vacuum Panel Handling Device

REF# 32704739\_1A01



Ingersoll Rand

Power rotate

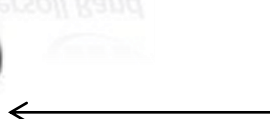

Vacuum

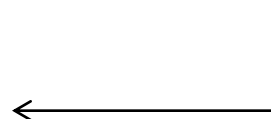

Ingersoll Rand  
2955 Stephenson Highway  
Madison Heights, MI 48071  
1-248-398-6200



INDEX

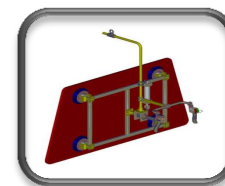

VACUUM



HANDLES



Description

Hook Panel Handling Device  
With Torque Tube

REF# 80778893\_1A01



INDEX

Ingersoll Rand  
2955 Stephenson Highway  
Madison Heights, MI 48071  
1-248-398-6200

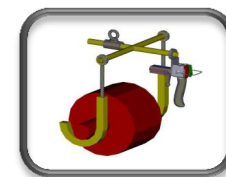

HOOK



HANDLES

Description  
Hook Panel Handling Device

REF# 80872574\_1A01



Ingersoll Rand  
2955 Stephenson Highway  
Madison Heights, MI 48071  
1-248-398-6200



INDEX

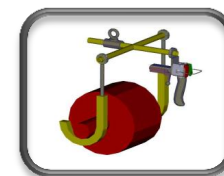

HOOK



HANDLES



Description  
Hook Panel Handling Device

REF# 32704516\_1A01



INDEX

Ingersoll Rand  
2955 Stephenson Highway  
Madison Heights, MI 48071  
1-248-398-6200

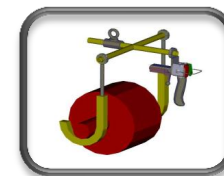

HOOK



HANDLES

Description

Hook Panel Handling Device  
With Torque Tube

REF# 32352761\_2A0



Ingersoll Rand  
2955 Stephenson Highway  
Madison Heights, MI 48071  
1-248-398-6200



INDEX

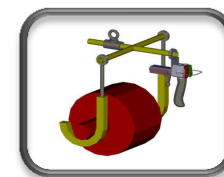

HOOK



HANDLES

Description  
Clamp Panel Handling Device

REF# 80621515\_1A01



Ingersoll Rand  
2955 Stephenson Highway  
Madison Heights, MI 48071  
1-248-398-6200



INDEX

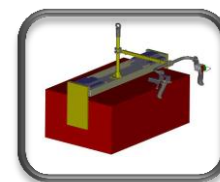

CLAMP





HANDLES



Description  
Clamp Box Handling Device

REF# 80515561\_1A01

**IR**  
Ingersoll Rand  
Ingersoll Rand

Ingersoll Rand  
2955 Stephenson Highway  
Madison Heights, MI 48071  
1-248-398-6200



INDEX

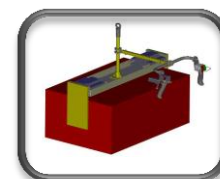

CLAMP



HANDLES

Description  
Clamp Panel Handling Device

REF# 32516669\_1A01



Manual Tilt 90 Degree



INDEX

Ingersoll Rand  
2955 Stephenson Highway  
Madison Heights, MI 48071  
1-248-398-6200

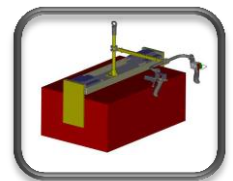

CLAMP



HANDLES



Description  
Clamp Panel Handling Device  
With Torque Tube

REF# 80778805\_1A0



INDEX

Ingersoll Rand  
2955 Stephenson Highway  
Madison Heights, MI 48071  
1-248-398-6200

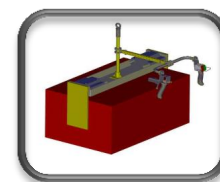

CLAMP



HANDLES

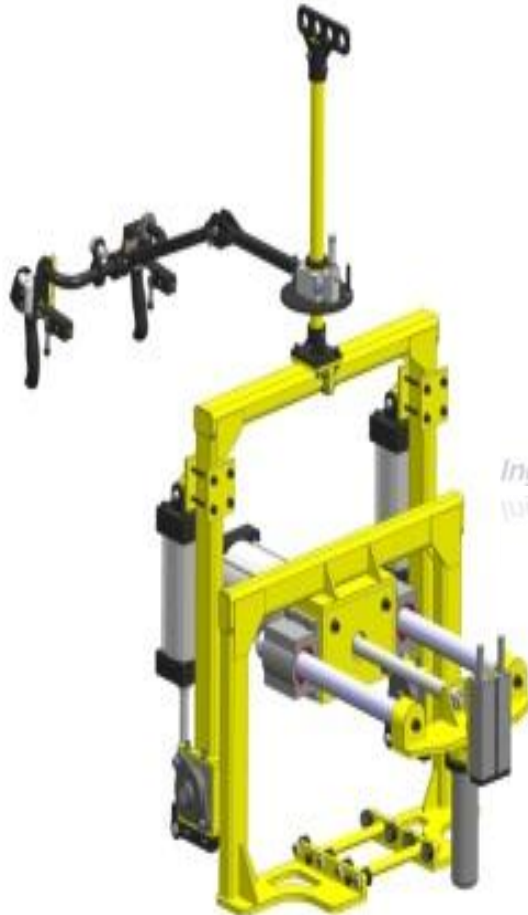

Description  
Clamp Panel Handling Device

REF# 32496020\_1A01



INDEX

Ingersoll Rand  
2955 Stephenson Highway  
Madison Heights, MI 48071  
1-248-398-6200

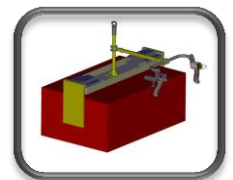

CLAMP



HANDLES

Description  
Clamp Roll Handling Device

REF# 80674356\_6A01\_ALT



Power Rotate



Ingersoll Rand  
2955 Stephenson Highway  
Madison Heights, MI 48071  
1-248-398-6200



INDEX

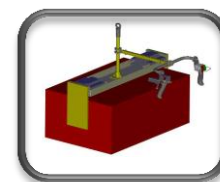

CLAMP



HANDLES

Description  
Clamp Panel Handling Device

REF# 32503515\_1A01



Power Rotate



INDEX

Ingersoll Rand  
2955 Stephenson Highway  
Madison Heights, MI 48071  
1-248-398-6200

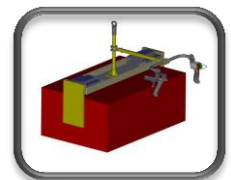

CLAMP



HANDLES



Description  
Clamp Handling Device

REF# 32437825\_1A01

Power Rotate

Ingersoll Rand  
2955 Stephenson Highway  
Madison Heights, MI 48071  
1-248-398-6200



INDEX

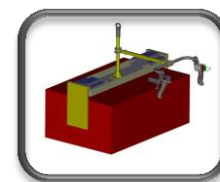

CLAMP





HANDLES

Description  
Clamp Handling Device

REF# 47505582001



Ingersoll Rand  
2955 Stephenson Highway  
Madison Heights, MI 48071  
1-248-398-6200



INDEX

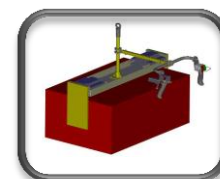

CLAMP



HANDLES

Description  
Trap Handling Device

REF# 80699048\_1A0



Ingersoll Rand  
2955 Stephenson Highway  
Madison Heights, MI 48071  
1-248-398-6200



INDEX

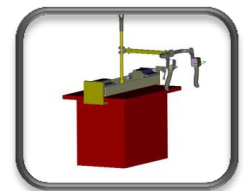

TRAP



HANDLES



Description  
Trap Handling Device

REF# 32704747\_1A0

Power Rotate



INDEX

Ingersoll Rand  
2955 Stephenson Highway  
Madison Heights, MI 48071  
1-248-398-6200

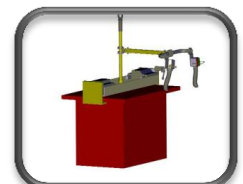

TRAP



HANDLES

Description  
Trap Handling Device

REF# 80326026\_2A01

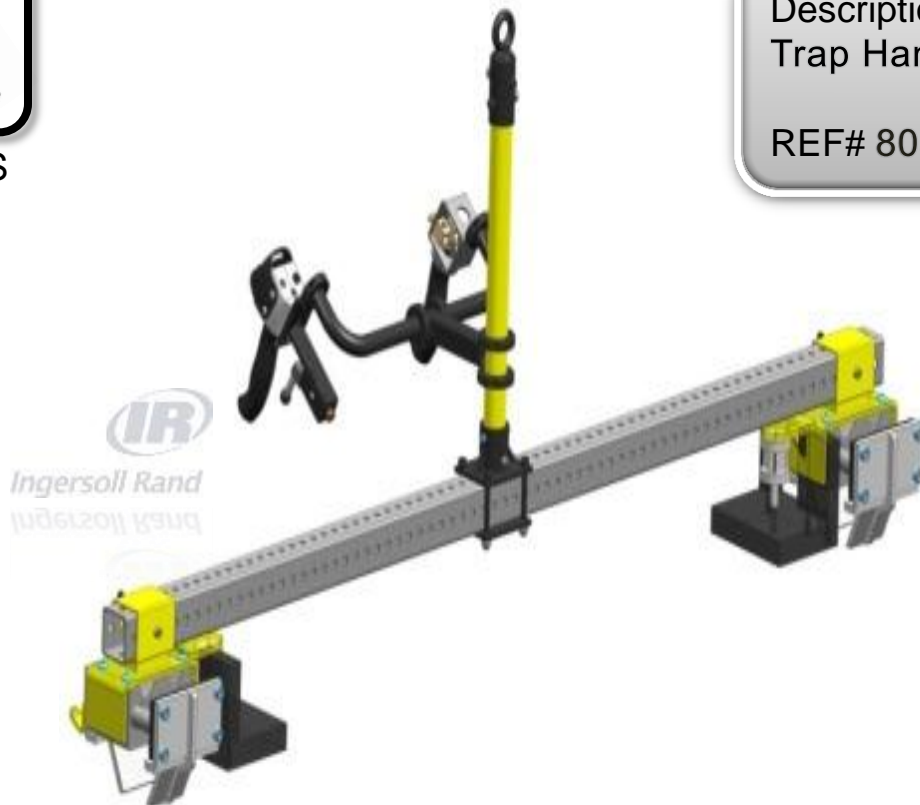

Ingersoll Rand  
2955 Stephenson Highway  
Madison Heights, MI 48071  
1-248-398-6200



INDEX

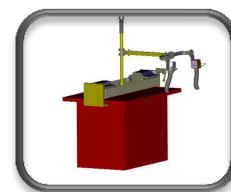

TRAP



HANDLES



Description  
Trap Handling Device

REF# 80458096\_1A01



INDEX

Ingersoll Rand  
2955 Stephenson Highway  
Madison Heights, MI 48071  
1-248-398-6200

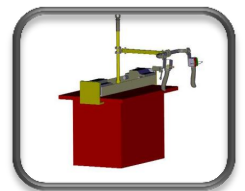

TRAP



HANDLES



Description  
Trap Handling Device

REF# 80441553\_2A01



INDEX

Ingersoll Rand  
2955 Stephenson Highway  
Madison Heights, MI 48071  
1-248-398-6200

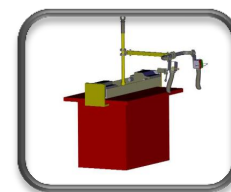

TRAP



HANDLES

Description  
Trap Handling Device

REF# 32687104\_1A01



Power Tilt Cylinder

Ingersoll Rand  
2955 Stephenson Highway  
Madison Heights, MI 48071  
1-248-398-6200



INDEX

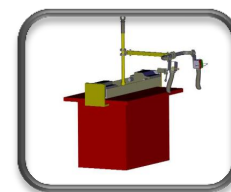

TRAP



Description  
Probe Rotary Action Handler

REF#

Safety Notification

Manual Release

Pivot Point



Nose Pieces



INDEX

Ingersoll Rand  
2955 Stephenson Highway  
Madison Heights, MI 48071  
1-248-398-6200

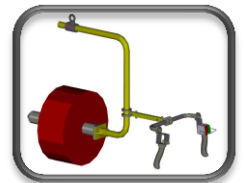

PROBE



HANDLES

Description  
Twin Probe Handling Device

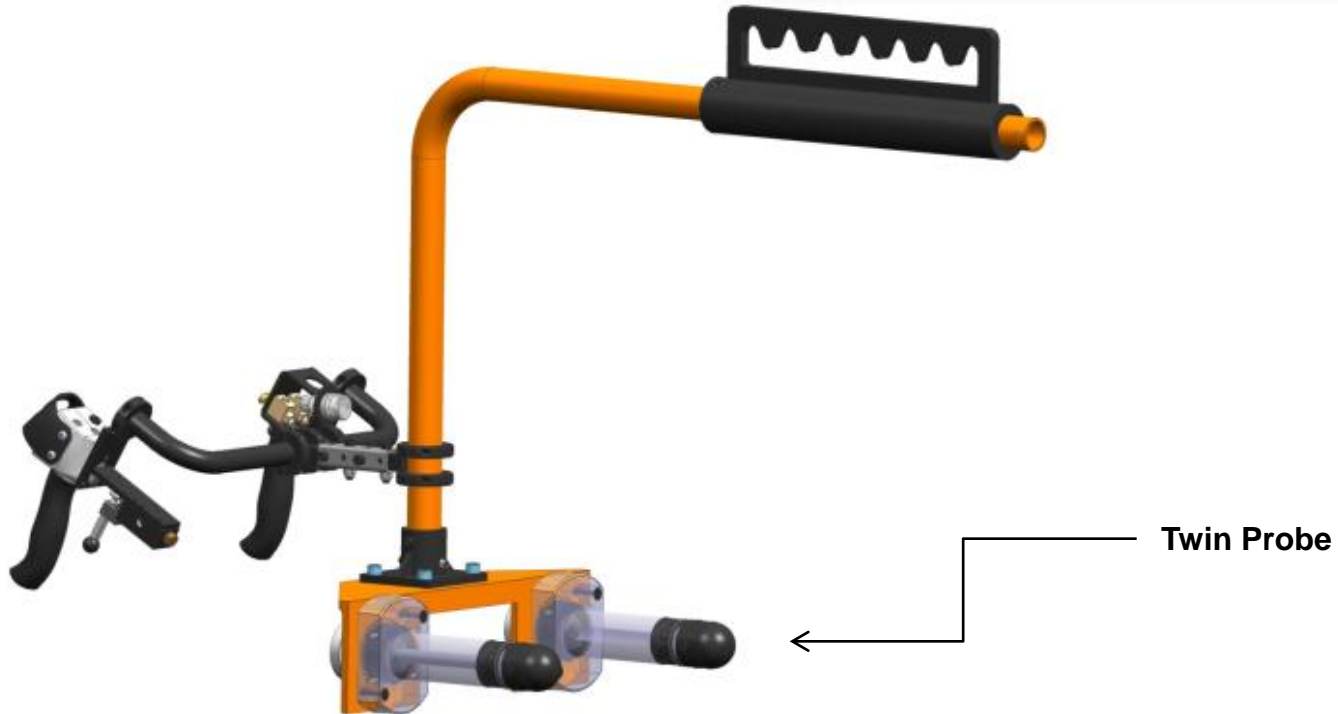

INDEX

Ingersoll Rand  
2955 Stephenson Highway  
Madison Heights, MI 48071  
1-248-398-6200

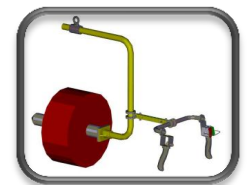

PROBE

Description

Air Balancers

Air Balancers Operate within a Capacity Range of 50 to 2000 lb (22 to 909 kg).

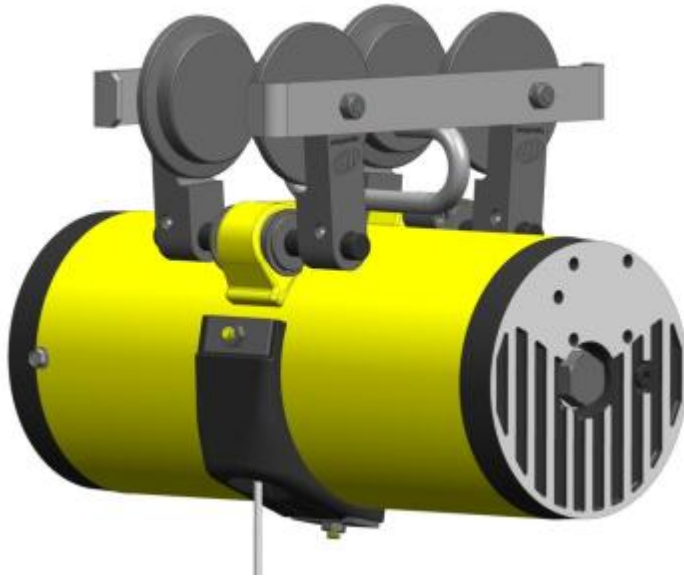

INDEX

Ingersoll Rand  
2955 Stephenson Highway  
Madison Heights, MI 48071  
1-248-398-6200



BALANCER

# E Series

## Floor Supported Crane Systems



Online Document  
System Selection

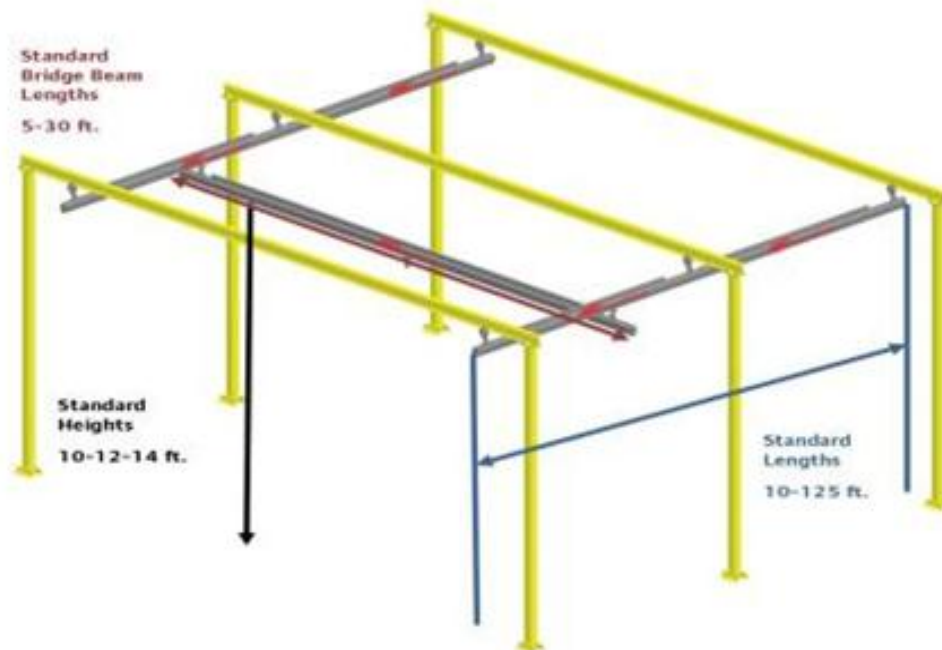

INDEX

Ingersoll Rand  
2955 Stephenson Highway  
Madison Heights, MI 48071  
1-248-398-6200

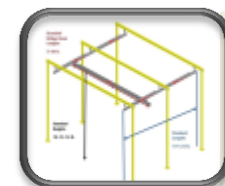

FLOOR SUPPORT



INDEX

Ingersoll Rand  
2955 Stephenson Highway  
Madison Heights, MI 48071  
1-248-398-6200







INDEX

Ingersoll Rand  
2955 Stephenson Highway  
Madison Heights, MI 48071  
1-248-398-6200





INDEX

Ingersoll Rand  
29555 Stephenson Highway  
Madison Heights, MI 48071  
1-248-398-6200







INDEX

Ingersoll Rand  
2955 Stephenson Highway  
Madison Heights, MI 48071  
1-248-398-6200





**Customer Support**  
**1-800-998-0872**



**NASC Order Status**  
**Order Status**



**Submit Quote and Questions :**  
**[asbu\\_proposal@irco.com](mailto:asbu_proposal@irco.com)**



INDEX

Ingersoll Rand  
2955 Stephenson Highway  
Madison Heights, MI 48071  
1-248-398-6200



SUPPORT

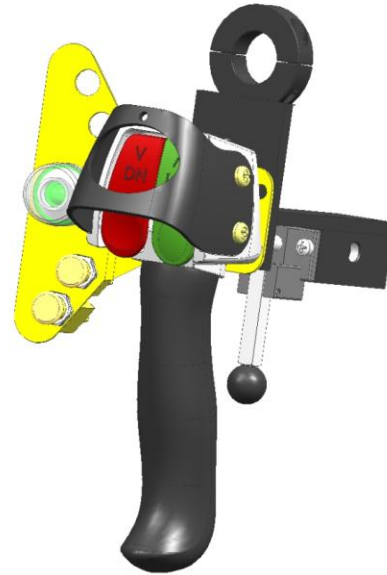
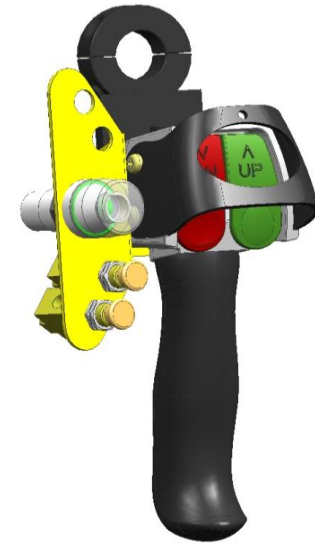

## Product and Application Examples

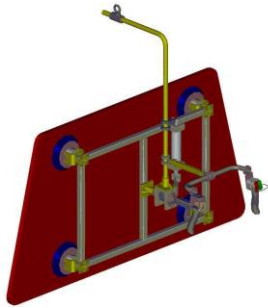

### Vacuum

- Venturi design
- Pneumatic Controls
- Part manipulation
- 1-6+ Vacuum Cups
- Applications: Sheet metal, glass, cardboard

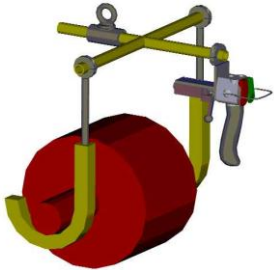

### Hook

- Single or multiple hook(s)
- Straight transfer
- Applications: Odd shaped parts with hook access

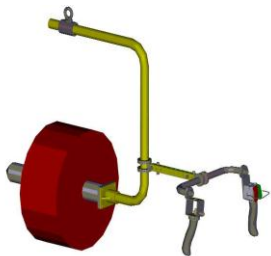

### Probe

- Manual or Pneumatic engagement
- Part manipulation
- Applications: Cylindrical parts with accessible core

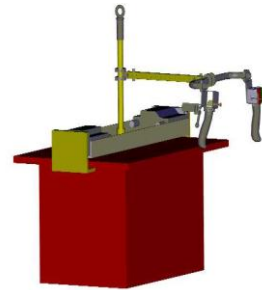

### Trap

- Manual or Pneumatic Powered
- Straight transfer
- Applications: Parts with accessible grab locations on both sides

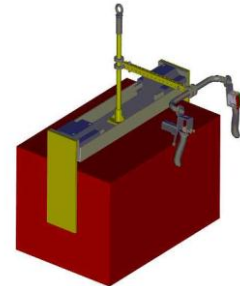

### Clamp

- Air Cylinder powered
- Pneumatic controls
- Part manipulation
- Applications: Rigid parts of varying shapes and sizes



Online Application Data Sheets

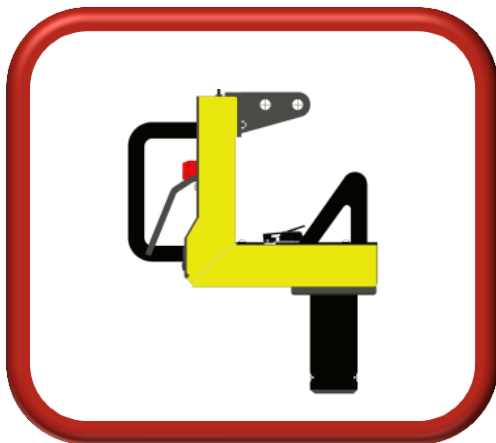
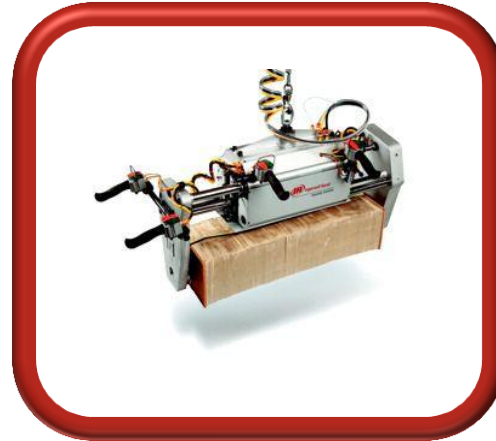
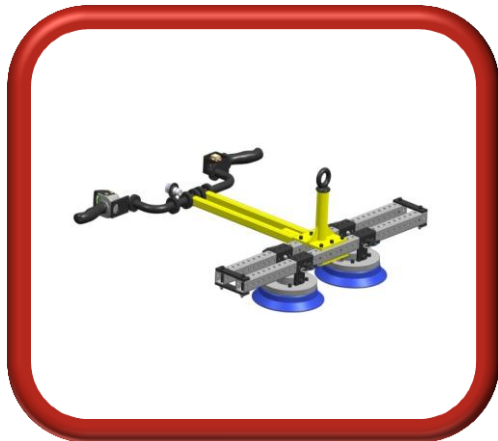

INDEX

Click On Icon To Go To Online Document





Click To  
Go Home



INDEX